

Media

Scale-2

2D Zeichnungen

Vorderansicht/
Front view

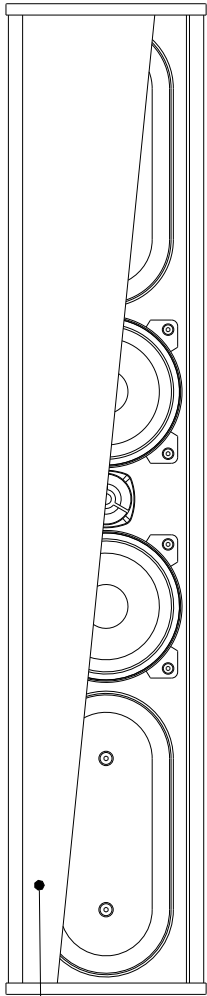

Stahlgitter mit
Akustikschaum hinterlegt/
Steel grille, backed by
acoustically transparent foam

Seitenansicht/
Side view



T-Nut für
Nutensteine M6/
T-slot for
slot nuts M6

Rückansicht/
Rear view

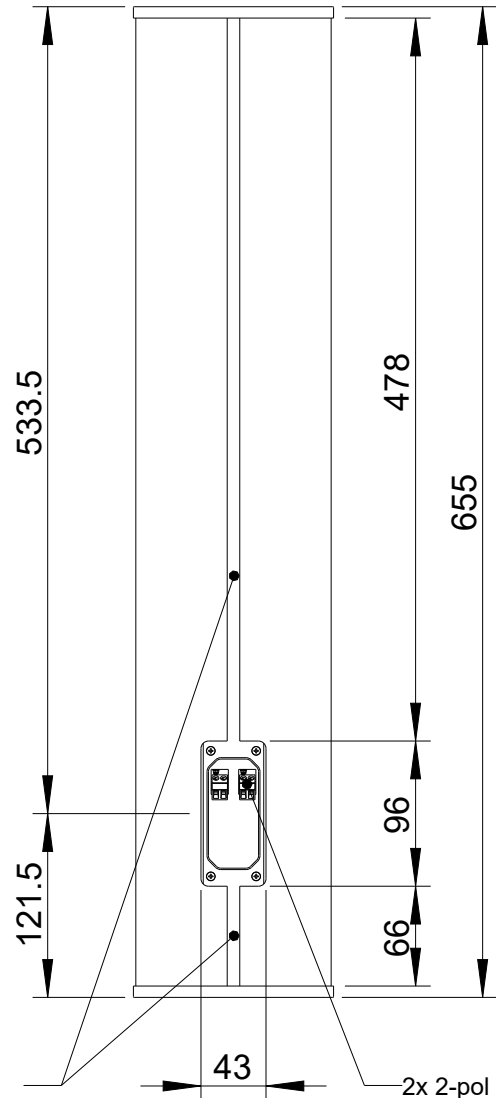

2x 2-pol
Phoenixklemme/
2x 2-pin
Phoenix terminal

Draufsicht/
Top view

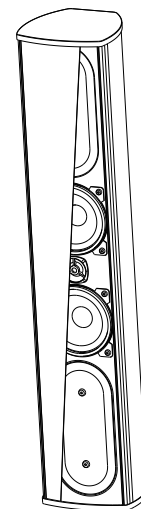
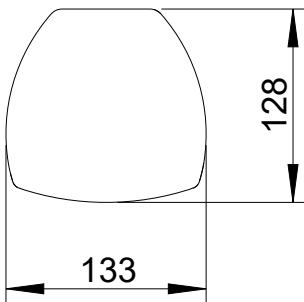

All data and dimensions are subject to change

Scale -2
5131-XXXXX

Vorderansicht/
Front view

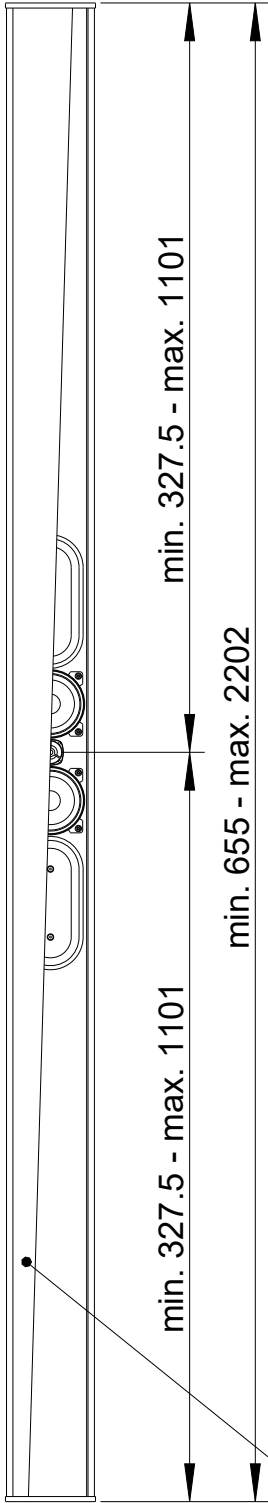

Seitenansicht/
Side view



Rückansicht/
Rear view

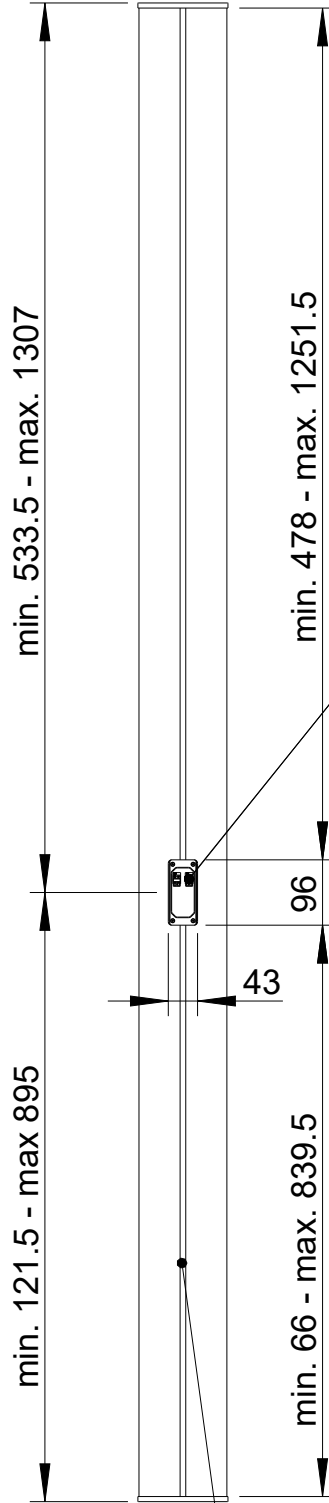

2x 2-pol
Phoenixklemme/
2x 2-pin
Phoenix terminal

Draufsicht/
Top view

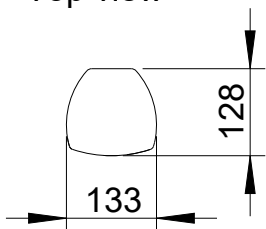

Stahlgitter, mit Akustikschaum
hinterlegt/
Steel grille, backed by
acoustically transparent foam

T-Nut für
Nutensteine M6/
T-slot for
slot nuts M6

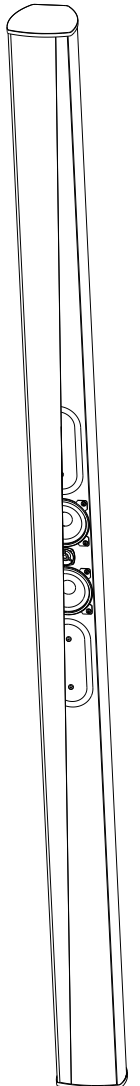

All data and dimensions are subject to change

Scale-2S
5133-xxxxx

Vorderansicht/
Front view

Seitenansicht/
Side view

Rückansicht/
Rear view

Geeignet für
Huddly IQ/
Suitable for
Huddly IQ

Abnehmbares
Frontgitter zur
Kameraausrichtung/
Removable front grille
for camera alignment

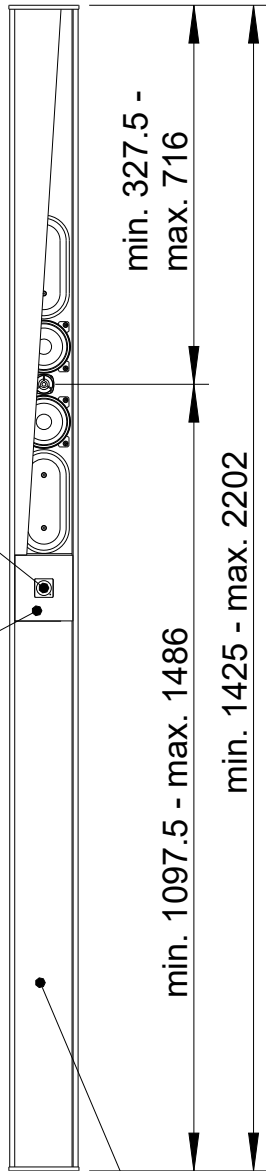
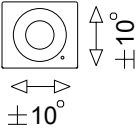

Stahlgitter, mit
Akustikschaum hinterlegt/
Steel grille, backed by
acoustically transparent foam

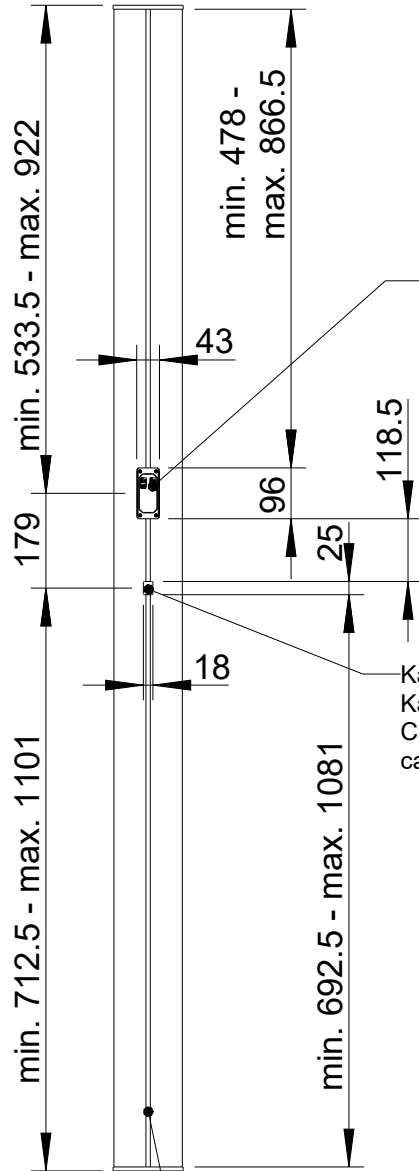
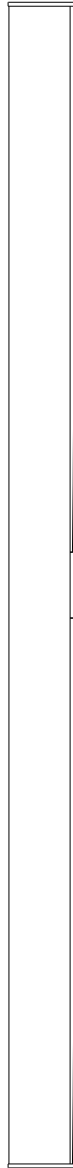

2x 2-pol
Phoenixklemme/
2x 2-pin
Phoenix terminal

Kabelauslass für
Kameraanbindung/
Cable outlet for
camera connection

T-Nut für
Nutensteine M6/
T-slot for
slot nuts M6

Draufsicht/
Top view

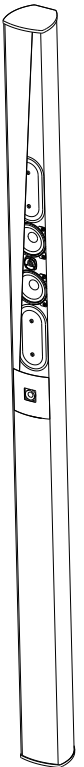
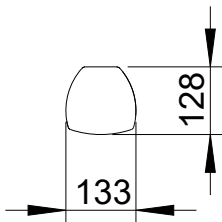

All data and dimensions are subject to change

Scale-2S + Cam
5140-xxxxx

Fohhn Audio AG
Großer Forst 15
72622 Nürtingen
Deutschland

Tel. +49 7022 93323-0
Fax +49 7022 93324-0
www.fohhn.com
info@fohhn.com



Die Fohhn Audio AG behält sich vor, unangekündigt Änderungen am Produktdesign oder Technologien vorzunehmen. Alle Angaben ohne Gewähr.

© 2022, Fohhn Audio AG, Deutschland.